

Full C.C.W Position

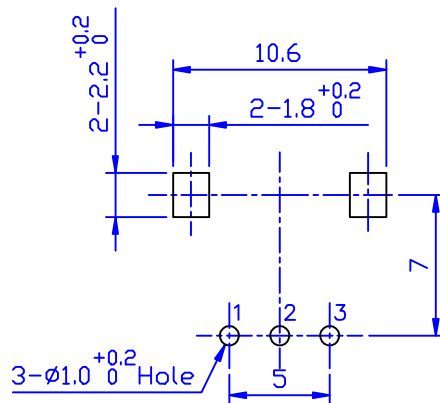

FN-TYPE

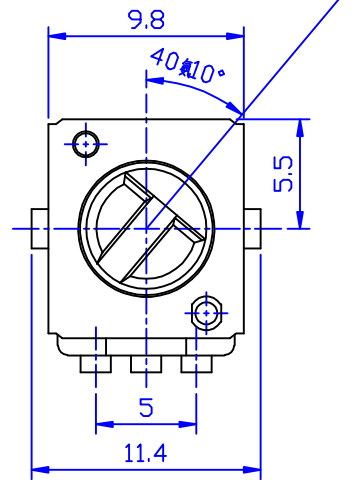
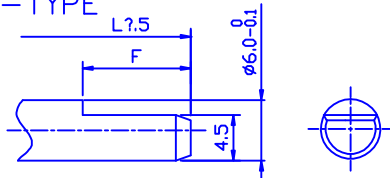

L	15	18	20	25	30	35
F	6	9	7	7	12	12

未指定容許尺寸之公差

10以下	± 0.3
10~100	± 0.5
100以上	± 0.8
角度	$\pm 5^\circ$

K-TYPE

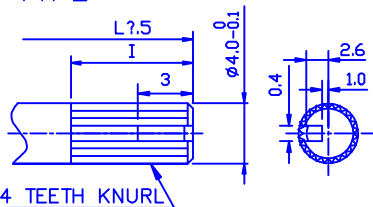

L	20	25	30	35
I	7	7	7	7

P-TYPE

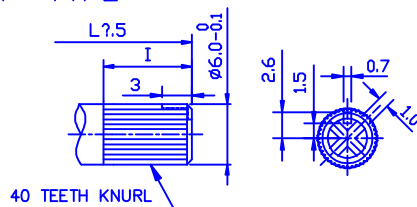

L	9.5	13	15	20	25	30	35
I	4	6	7	7	7	7	7

C-TYPE

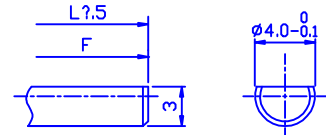

L	12.5
F	4.5

F-TYPE

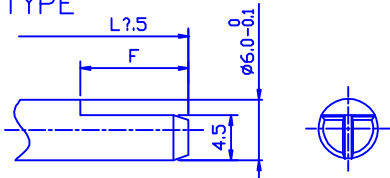

L	15	18	20	25	30	35
F	6	9	7	7	12	12

Y-TYPE

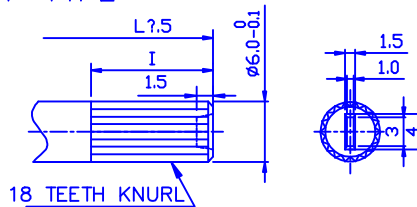

L	20	25	30	35
I	7	7	7	7

T-TYPE

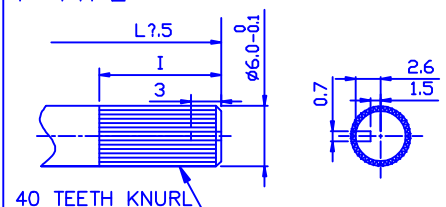

L	15	20	25	30	35
I	6	7	7	7	7



東莞市立助達電子有限公司
DONGGUAN UMS ELECTRONIC CO.,LTD.

△5					UNIT	SCALE	TITLE
△4					MM	3 / 1	M-09K Series
△3					DRAWN	DESIGN	DWG NAME
△2					Z L		M-09KH
△1							DWG NO.
DEVISION	DATE	DESIGN	13.04.22				